

EMC Components

Ferrite Bead Filters

Lead

ZBF Series

FEATURES

- With an impedance greater than 30Ω across the 30 to 1000MHz frequency range, these ferrite beads absorb noise by resistance at high frequencies.
- Good high frequency characteristics due to low distributed capacitance.
- These are radial lead-type ferrite beads, so can be mounted on PCBs using automatic equipment insertion.

APPLICATIONS

Home electronics (TVs, video equipment, PCs, digital equipment equipped with microcomputers, etc.), office automation equipment (computers, terminals, stand-alone word processors, fax machines, etc.), factory automation equipment (industrial measuring equipment, meters, switching power sources, etc.), radio equipment (car phones, business mobile radios, transceivers, amateur radios, etc.). Used to control undesirable electromagnetic radiation, suppress abnormal oscillations, and avoid abnormal operation. For items used in the USA, particularly effective in meeting the requirements for FCC Part 15, subpart J approval for digital equipment. Particularly effective in countering EMI so as to comply with VCCI (Japan) and FTZ (German) regulations.

SHAPES AND DIMENSIONS

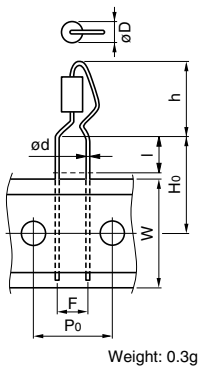
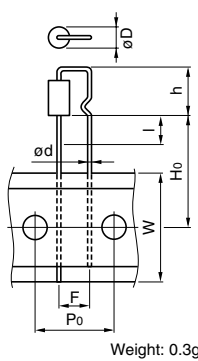
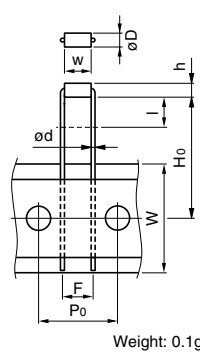
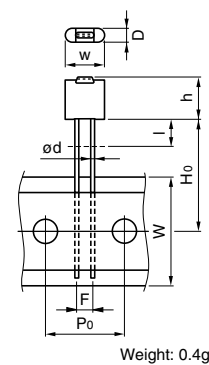
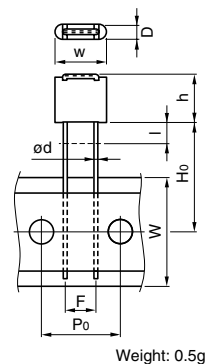
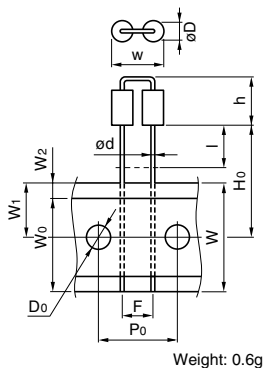
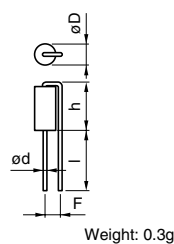
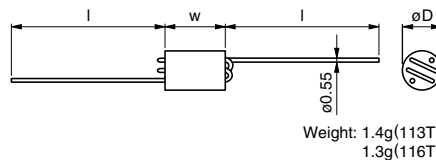
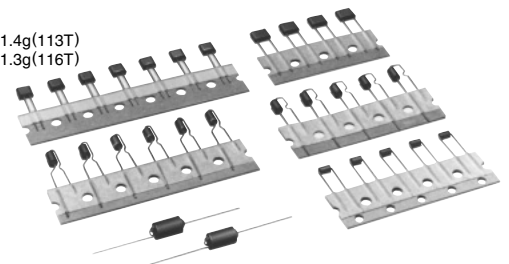
ZBF503S-01(TA)

ZBF503S-03(TA)-K

ZBF503AR-00(TA)

ZBF253D-00(TA)

ZBF503D-00(TA)
ZBF504D-00(TA)
ZBF506D-00(TA)

ZBF503M-00(TA)-K

ZBF253S-01

ZBF113T-01
ZBF116T-01A

 Weight: 1.4g(113T)
 1.3g(116T)

Dimensions in mm

Part No.	D	w	h	l	d	F	Ho	Do	W	W0	W1	W2	P0	P1
ZBF253S-01	3.5	—	8max.	10	0.6	2.5	—	—	—	—	—	—	—	—
ZBF503S-01(TA)*	3.5	—	12.5max.	6	0.6	5	16	4±0.2	18+1, -0.5	12±0.3	9±0.5	(4)	12.7±0.3	6.35±0.4
ZBF503S-03(TA)*-K	3.5	—	8max.	10	0.6	5	18.5	4±0.2	18+1, -0.5	12±0.3	9±0.5	(4)	12.7±0.3	6.35±0.4
ZBF503AR-00(TA)*	2.3	4.5	2.3	5	0.6	5	20	4±0.2	18+1, -0.5	12±0.3	9±0.5	(4)	12.7±0.3	6.35±0.4
ZBF253D-00(TA)*	2.3	6.5max.	7max.	4.5	0.6	2.5	18.5	4±0.2	18+1, -0.5	12±0.3	9±0.5	(4)	12.7±0.3	6.35±0.4
ZBF503D-00(TA)*	2.5max.	8.5max.	8max.	4.5	0.6	5	18.5	4±0.2	18+1, -0.5	12±0.3	9±0.5	(4)	12.7±0.3	6.35±0.4
ZBF504D-00(TA)*	2.5max.	8.5max.	8max.	4.5	0.6	5	18.5	4±0.2	18+1, -0.5	12±0.3	9±0.5	(4)	12.7±0.3	6.35±0.4
ZBF506D-00(TA)*	2.5max.	8.5max.	8max.	4.5	0.6	5	18.5	4±0.2	18+1, -0.5	12±0.3	9±0.5	(4)	12.7±0.3	6.35±0.4
ZBF503M-00(TA)*-K	3.5	8.6	8max.	7	0.6	5	18.5	4±0.2	18+1, -0.5	12±0.3	9±0.5	(4)	12.7±0.3	6.35±0.4
ZBF113T-01	6	10	—	25.4	0.55	—	—	—	—	—	—	—	—	—
ZBF116T-01A	6	10	—	20	0.55	—	—	—	—	—	—	—	—	—

*Available for taping specifications. In this case please add "TA" at the end of part number.

EMC Components

ZBF Series

Ferrite Bead Filters

Lead

ELECTRICAL CHARACTERISTICS

Part No.	Rated voltage Edc (V)	Rated current (A)	Impedance vs. frequency(MHz)				DC resistance (Ω)max.
			30 Ω min.	50 Ω min.	100 Ω min.	600 Ω min.	
ZBF253S-01	50	3	10 to 300				0.01
ZBF503S-01(TA)	50	3	10 to 300				0.01
ZBF503S-03(TA)-K	50	3	30 to 300				0.01
ZBF503AR-00(TA)	50	3	100 to 1000				0.01
ZBF253D-00(TA)	50	3	5 to 300	15 to 300			0.01
ZBF503D-00(TA)	50	3	5 to 300	15 to 300			0.01
ZBF504D-00(TA)	50	3	7 to 300	30 to 300			0.01
ZBF506D-00(TA)	50	3	30 to 1000	70 to 1000			0.01
ZBF503M-00(TA)-K	50	3		10 to 300			0.01
ZBF113T-01	50	3			3 to 300	30 to 70	0.04
ZBF116T-01A	50	3			10 to 300	50 to 100	0.04

• Operating temperature range: -25 to +85°C

TYPICAL ELECTRICAL CHARACTERISTICS

IMPEDANCE vs. FREQUENCY CHARACTERISTICS

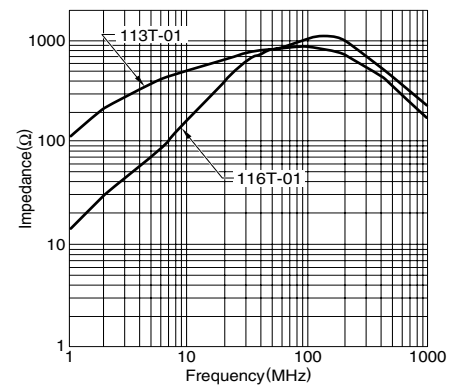
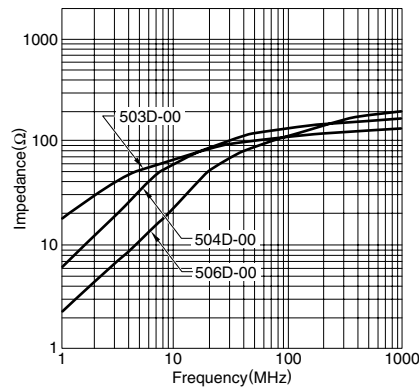
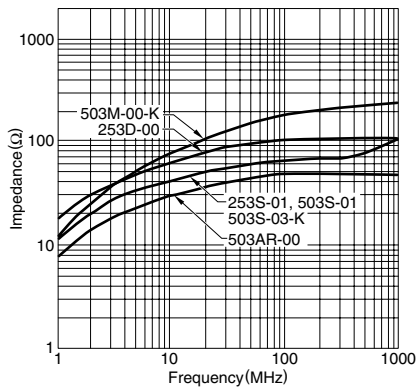

TYPICAL EMC SUPPRESSION EFFECTS

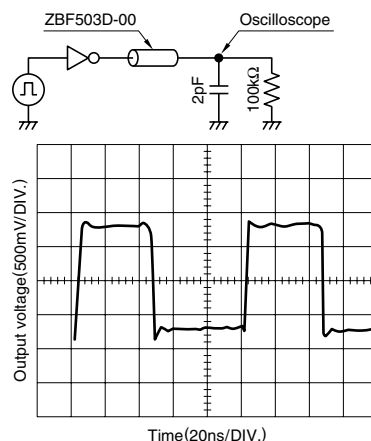
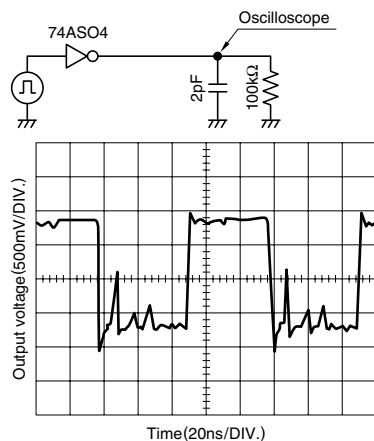

MEASURING CIRCUIT

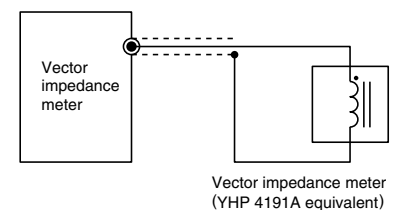

EMC Components

ZBF Series

Ferrite Bead Filters

Lead

PACKAGING STYLE AND QUANTITIES(AMMO-PACKAGING)

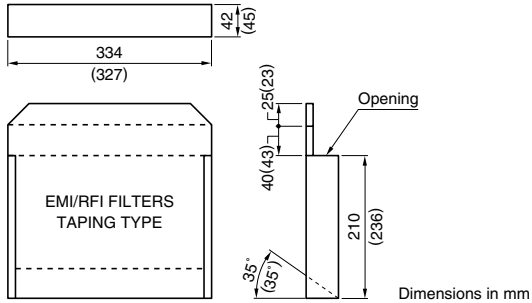

The dimension indicated within parentheses is used during packing of the ZBFS503S-01TA.

Part No.	Quantity
ZBF503S-01TA	2500 pieces/box
ZBF503S-03TA	2500 pieces/box
ZBF503AR-00TA	2500 pieces/box
ZBF253D-00TA	2000 pieces/box
ZBF503D-00TA	2000 pieces/box
ZBF504D-00TA	2000 pieces/box
ZBF506D-00TA	2000 pieces/box
ZBF503M-00TA-K	1500 pieces/box